

BOSE[®] Link AL8

HOMEWIDE WIRELESS AUDIO LINK

Owner's Guide

Brugervejledning

Bedienungsanleitung

Guía de usuario

Notice d'utilisation

Manuale di istruzioni

Gebruiksaanwijzing



Bruksanvisningen



SAFETY INFORMATION

Please read this owner's guide

Please take the time to follow the instructions in this owner's guide carefully. It will help you set up and operate your system properly and enjoy its advanced features. Please save this owner's guide for future reference.

-  **WARNING:** To reduce the risk of fire or electrical shock, do not expose the product to rain or moisture.
-  **WARNING:** The apparatus shall not be exposed to dripping or splashing, and objects filled with liquids, such as vases, shall not be placed on the apparatus. As with any electronic product, use care not to spill liquids into any part of the system. Liquids can cause a failure and/or a fire hazard.



The lightning flash with arrowhead symbol within an equilateral triangle alerts the user to the presence of uninsulated, dangerous voltage within the system enclosure that may be of sufficient magnitude to constitute a risk of electric shock.



The exclamation point within an equilateral triangle alerts the user to the presence of important operating and maintenance instructions in this owner's guide.

-  **WARNING:** No naked flame sources, such as lighted candles, should be placed on the apparatus.

 **Note:** The product label is located on the bottom of the product.

This product is intended to be used only with the power supply provided. Where the mains plug is used as the disconnect device, such disconnect device shall remain readily operable.

This product must be used indoors. It is neither designed nor tested for use outdoors, in recreation vehicles, or on boats.

 This product conforms to the EMC Directive 89/336/EEC and to the Low Voltage Directive 73/23/EEC. The complete Declaration of Conformity can be found at www.bose.com.

 This product conforms to the RTTE Directive (99/5/EC). The complete Declaration of Conformity can be found at www.bose.com.

Important safety instructions

1. **Read these instructions** – for all components before using this product.
2. **Keep these instructions** – for future reference.
3. **Heed all warnings** – on the product and in the owner's guide.
4. **Follow all instructions.**
5. **Do not use this apparatus near water** – Do not use this product near a bathtub, washbowl, kitchen sink, laundry tub, in a wet basement, near a swimming pool, or anywhere else that water or moisture are present.
6. **Clean only with a dry cloth** – and as directed by Bose Corporation. Unplug this product from the wall outlet before cleaning.
7. **Do not block any ventilation openings. Install in accordance with the manufacturer's instructions** – To ensure reliable operation of the product and to protect it from overheating, put the product in a position and location that will not interfere with its proper ventilation.
8. **Do not install near any heat sources, such as radiators, heat registers, stoves, or other apparatus (including amplifiers) that produce heat.**
9. **Only use attachments/accessories specified by the manufacturer.**
10. **Unplug this apparatus during lightning storms or when unused for long periods of time** – to prevent damage to this product.
11. **Refer all servicing to qualified service personnel. Servicing is required when the apparatus has been damaged in any way: such as power supply cord or plug is damaged; liquid has been spilled or objects have fallen into the apparatus; the apparatus has been exposed to rain or moisture, does not operate normally, or has been dropped.**

©2006 Bose Corporation. No part of this work may be reproduced, modified, distributed or otherwise used without prior written permission.

Ultra Low Delay Audio Coding licensed by Fraunhofer IIS

INTRODUCTION	4
The Bose® link AL8 Homewide Wireless Audio Link	4
Unpacking the carton	4
What distinguishes the two units	5
Choosing a place for each unit	5
SETUP	6
Making the connections	6
For the transmitter	6
For the receiver	7
Connecting to power	7
Instructions for non-Bose or older Bose products	8
Check the indicators and settings	9
The Status LED	9
The transmitter Channel button	9
Your Bose® link expansion room remote control	10
Your Bose link expansion room product	10
Enjoy your wireless entertainment	10
REFERENCE	11
Accessories	11
Troubleshooting	11
Contacting Customer Service	12
Limited warranty	12
Technical Information	13

For Your Records

Serial numbers are located on the bottom of the AL8 transmitter and the receiver.

Serial numbers: Transmitter: _____ Receiver: _____

Dealer name: _____

Dealer phone: _____ Purchase date: _____

Bose recommends that you keep your sales slip and a copy of your product registration card together with this guide.

INTRODUCTION

The Bose® link AL8 Homewide Wireless Audio Link

Congratulations on your choice of Bose to provide an audio expansion solution free from the need to run cumbersome wires between rooms.

The audio link consists of a transmitter and receiver. They deliver audio signals from your LIFESTYLE® 18 or 28 Series II system or LIFESTYLE® 38 or 48 system in one area of your house to the system or speakers you have set up in another area.

One transmitter can also send signals to as many as eight receivers, making it simple to add on to your system whenever you like.

🎵 **Note:** For future expansion possibilities, we recommend that you keep this owner's guide as a reference.

In combination with a Bose® link remote control or the PERSONAL® music center II, the Bose link AL8 Homewide Wireless Audio Link gives you numerous options for expanding your enjoyment.

Unpacking the carton

Carefully unpack the carton and save all packing materials for possible future use. They provide the most secure way to transport the product.

Check to be sure your system includes all of the parts shown (Figure 1). If any part appears damaged, do not attempt to use it. Notify Bose or your authorized Bose dealer immediately. For Bose contact information, refer to the address sheet included in the carton.

Figure 1

Carton contents

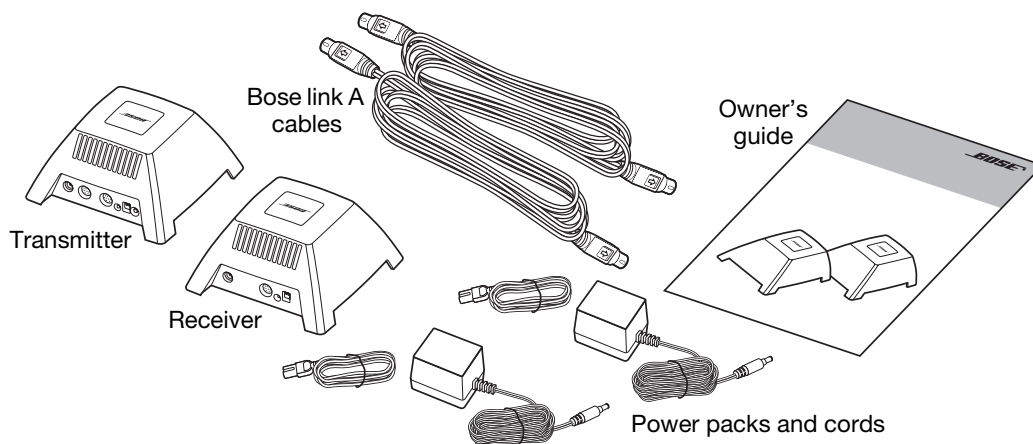

🎵 **Note:** Now is a good time to find the serial numbers on the bottom of the transmitter and the receiver. Copy them onto your product registration card and in the space provided on "For Your Records" on page 3.

What distinguishes the two units

The connection panel on each unit identifies it by name: TRANSMITTER or RECEIVER. Two Bose® link jacks and a Channel button further distinguish the transmitter.

For compatibility, the two units have a matching Setup Code, set at the factory with both switches in the “down” position (Figure 2). A Status LED lights when each unit is plugged in and the two units are communicating.

Figure 2

Connection panels on the two units

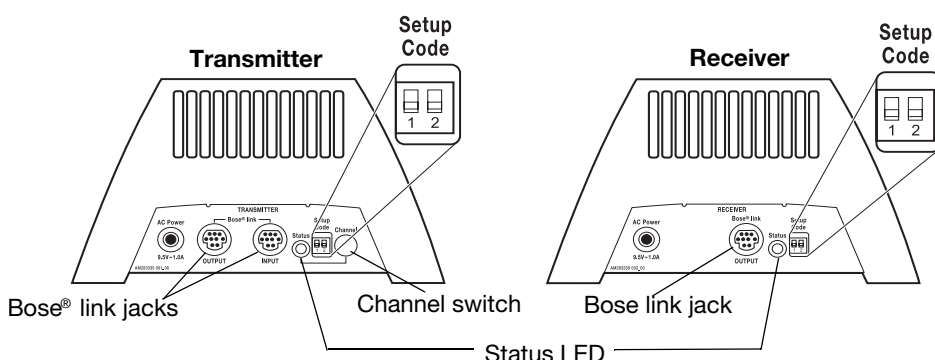

Note: For information on the meaning of the different Status LED lights, refer to “Check the indicators and settings” on page 9.

Choosing a place for each unit

Place the transmitter in the same room with the LIFESTYLE® system media center. Place the receiver in the same room with your Bose® link expansion product.

Note: Use of the audio link with products that are not Bose link-compatible requires an adapter cable. For further information, refer to “Instructions for non-Bose or older Bose® products” on page 8.

Considerations for positioning:

- Place each unit upright with all feet flat on a level surface, such as a floor, table, or shelf.
- Do not tip either unit on its side.
- Place each unit within 2 meters (7 feet) of the product to which it is connected (using the supplied Bose link A cable).
- Keep the two units within 23 meters (75 feet) of each other.
- Be aware that the strongest signal direction is above and around, not below, the transmitter.

SETUP

Making the connections

You can connect one transmitter and up to eight receivers for each LIFESTYLE® system.

The transmitter and receiver each use one of the two supplied Bose® link A cables, which are 7 feet (2 meters) long. Each unit also connects to power using one of the two supplied power packs.

🎵 **Note:** Instructions for use with a non-Bose tuner/receiver vary slightly from those below. For details, refer to “Instructions for non-Bose or older Bose® products” on page 8.

For the transmitter

1. Connect one end of a Bose link A cable to the jack labeled Bose® link INPUT on the transmitter connection panel.
2. Connect the other end of the cable to the Bose link speaker jack, below the Main Speaker jack, on the LIFESTYLE® media center connection panel (Figure 3).

Figure 3

Transmitter connecting to a LIFESTYLE® media center

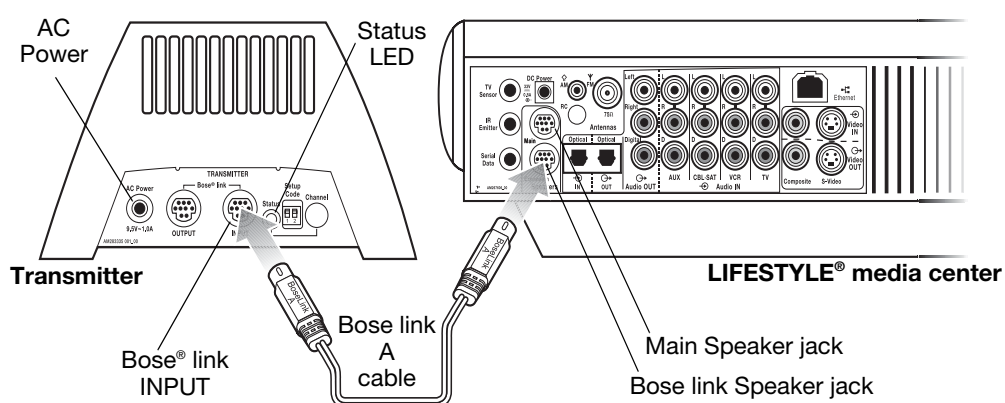

🎵 **Note:** If another product is already connected to the Bose link Speaker jack on the media center, disconnect it there. You can use the wireless audio link to replace this wired connection. Or, to continue using this connection, reconnect the cable to the jack labeled Bose link OUTPUT on the transmitter connection panel (Figure 4).

Figure 4

Transmitter and another product connecting to a LIFESTYLE® media center

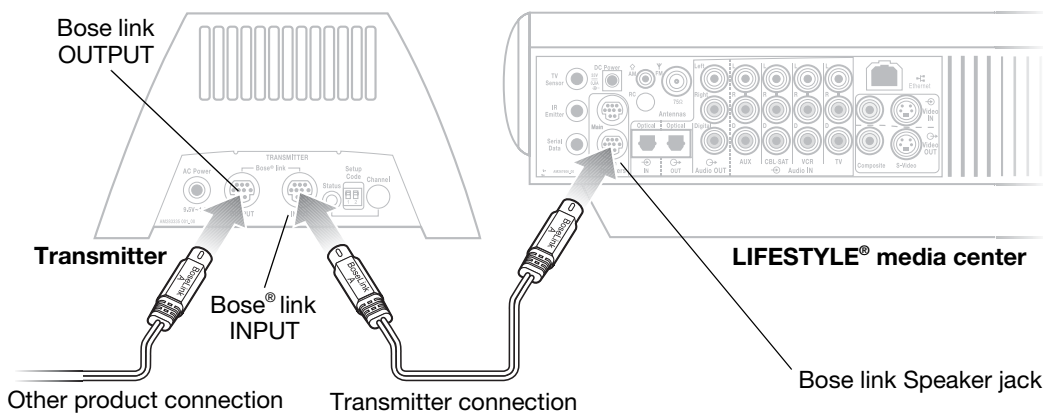

See “Connecting to power” on page 7 to complete your setup of the transmitter.

For the receiver

1. Connect one end of the second Bose® link A cable to the jack labeled Bose® link OUTPUT on the receiver.
2. Connect the other end of the cable to the Bose link Input jack on the expansion room system, amplifier, or powered speaker (Figure 5).

Figure 5

Connection to a Bose link amplifier, as an example

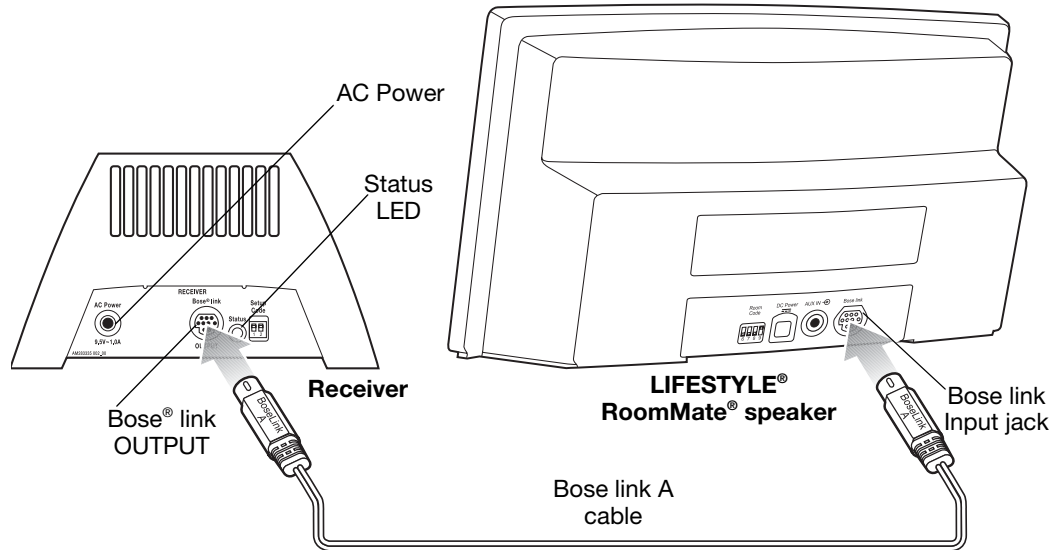

Connecting to power

1. Insert the small plug on the power pack cable into the AC Power jack on the transmitter or receiver (Figure 6).
2. Insert the small connector end of the power cord into the jack on power pack. Plug the other end of the cord into an AC (mains) wall outlet. The Status LED lights to verify this power connection.

Figure 6

Connecting the power pack and cord

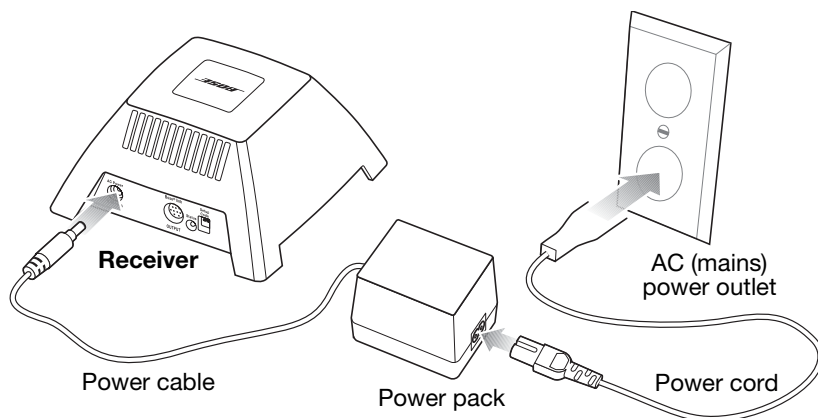

🎵 **Note:** For information on the meaning of the different Status LED lights, refer to “Check the indicators and settings” on page 9.

Instructions for non-Bose or older Bose® products

The Bose® link AL8 Homewide Wireless Audio Link also works with some products that are not Bose link-compatible.

You can use non-Bose products in the following ways:

- A tuner/receiver as a sound source connected to the transmitter or in an expansion room connected to the receiver
- Powered speakers connected to the receiver

You can use older Bose products as follows:

- Powered speakers, a radio, or system with its own volume and on/off controls and line-level female RCA input jacks connected to the receiver

Any of the above products require the use of an RCA to DIN adapter cable for connecting to the transmitter, the receiver, or both. An adapter kit, which contains two of these cables, is available from Bose.

Note: To order the adapter kit, contact Bose and request Part Number 285320-207. For Bose contact information, refer to the address sheet included in the carton.

To use an adapter cable:

The RCA connectors are color-coded, red for right and white for left.

1. Insert the adapter cable DIN connector into the Bose® link jack on the transmitter (INPUT) or receiver (OUTPUT) jack, as appropriate.
2. Insert the adapter cable RCA connectors into the Audio Out jack on the connection panel of the audio source or the Audio In jack on the expansion room product. Match left to left and right to right.

Figure 7

Connections using the adapter cable

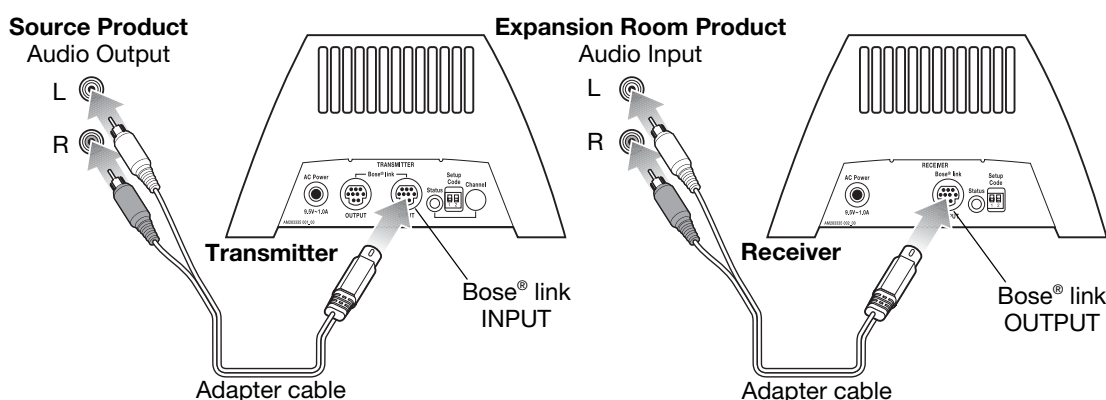

3. Complete the connections using the power pack:
 - Insert the small plug on the power pack cable into the AC Power jack on the transmitter or receiver.
 - Insert the small connector end of the power cord into the jack on the power pack. Plug the other end of the cord into an AC (mains) wall outlet. The Status LED lights to verify this power connection.

Note: For information on the meaning of the different Status LED lights, refer to “Check the indicators and settings” on page 9.

In the room where your AR1 receiver is connected using the adapter cable, be sure to set your Bose link remote or PERSONAL® music center II for use in Room “O.”

To control volume when a non-Bose product is the sound source:

- There is no need for an expansion room remote control.
- Use the remote that came with the tuner/receiver in the room where it is connected to the transmitter.
- Use the volume control on the system, radio, or powered speakers connected to the receiver in the other room.

To control non-Bose or older Bose® products in the expansion room:

- Use a Bose® link remote control or the PERSONAL® music center II to select audio from the LIFESTYLE® system in the main room.
- Use the product remote or console control for local volume adjustments.

Check the indicators and settings

Before you use the audio link, you may want to check some of the indicators and settings that make your expansion products work together smoothly.

The Status LED

On the connection panel of both the transmitter and the receiver, the Status LED indicates how the two units are communicating, as shown in the table below.

Status LED	Blinking green	Solid green	Blinking orange	Solid orange
On the transmitter	Searching for receiver	Receiver located	Not applicable	Powered on, no communication
On the receiver	Searching for transmitter	Solid signal received	Weak signal received	Weak or no signal received

On the receiver, a blinking or solid orange light indicates a communications problem. Repositioning the transmitter, receiver, or both, may resolve the problem and cause both LEDs to change to solid green. For further information, refer to “Troubleshooting” on page 11.

The transmitter Channel button

You can use the Channel button to narrow the selection of frequencies the transmitter uses.

The transmitter is factory-set to avoid WiFi Channel 11. This helps prevent performance problems, such as slow or intermittent data transmissions, on a wireless network. If you have a wireless network set up on another channel, you can set up your transmitter to avoid that channel, or you can move the WiFi network to Channel 11.

To reserve a channel for use by your WiFi network:

1. Press and hold the Channel button for more than 3 seconds to reach the setting for NO WIFI NETWORK. The Status LED blinks red three times to confirm this move.
2. In the grouping below, locate the channel used by your nearby WiFi network:
NO WIFI NETWORK...11...6...1...2...3...4...5...7...8...9...10...12...13.
3. Count the number of forward moves it takes from the NO WIFI NETWORK setting to reach your WiFi network channel. For example, if your WiFi network uses Channel 3, you need to move forward five times to reserve Channel 3 for WiFi network use only.
4. Press the Channel button for less than 3 seconds for each forward move. Repeat as many times as needed to reach the channel you want to reserve. The Status LED will blink red to confirm each move.

If the WiFi network channel is unknown to you, use the Channel button to switch off one channel at a time. Test the WiFi network to see which setting gives you the best effect.

If you do not have a WiFi network in your home:

Follow Step 1 above to use the entire frequency band and maximize transmitter performance.

Your Bose® link expansion room remote control

- Room code

If you have more than one LIFESTYLE® system expansion room, make sure the remote used in each one has a unique room code.

- House code

The house code setting on the remote must match the setting on your LIFESTYLE® system. It may not match if you changed the system house code due to interference with another system.

For information on these house code and room code settings and how to change them, refer to the owner's guide that came with your remote.

 **Note:** Setup codes for the transmitter and receiver, which must be identical to each other, do NOT need to match house codes on the remote or LIFESTYLE® system.

Your Bose® link expansion room product

- Room code

Make sure the system, amplifier, or powered speaker room code setting matches that of the remote you are using in the expansion room.

For information on room code settings and how to change them, refer to the owner's guide that came with your Bose link product.

Enjoy your wireless entertainment

With the settings confirmed, your Bose link AL8 Homewide Wireless Audio Link is ready for use. To explore and enjoy all of the capabilities provided by your expansion products, refer to the owner's guide provided with each product.

Accessories

Bose offers additional receivers as well as extension/expansion cables and adapter kits for use with the Bose® link AL8 Homewide Wireless Audio Link.

For further information, contact your Bose dealer or Bose Customer Service. For Bose contact information, refer to the address sheet included in the carton.

Troubleshooting

Problem	What to do
No sound	<ul style="list-style-type: none"> • For both the transmitter and the receiver, make sure: <ul style="list-style-type: none"> – the audio source is plugged in, turned on, and working. – both the transmitter and receiver are properly plugged into functioning AC power outlets. Refer to “Connecting to power” on page 7. – the Bose® link A cable is securely connected at both ends. Refer to “Making the connections” on page 6. – the small connector end of the power cord is inserted firmly into the AC Power jack on the connection panel and the power pack is plugged securely into a working AC outlet. – the Setup code switches on the connection panel of the transmitter and the receiver are set identically. There are four options: 1 & 2 up; 1 & 2 down; 1 up & 2 down; 1 down & 2 up. – the Status LEDs are lit a solid green to indicate solid communication between the two parts. If not, refer to the next Problem in this table. • For the expansion room products, make sure: <ul style="list-style-type: none"> – the system, amplifier, or powered speaker is plugged in and turned on. On an SA-2 or SA-3 amplifier in that room, make sure the Status LED is lit to indicate the amplifier is working. – the room code is set on the Bose link remote control or PERSONAL® music center II to match the room codes on the amplifier or powered speaker and are unique to this expansion room. – the house code is set on the Bose link remote control or PERSONAL® music center II to match the house code of the LIFESTYLE® system in the main room.
Above problem persists and the Status LED lights are not solid green	<ul style="list-style-type: none"> • Move the receiver and transmitter closer together. • Move the receiver, the transmitter, or both so the transmission path between them does not intersect with large metal objects (like a refrigerator), impervious construction materials (like thick masonry), or other obstructions (like a pool of water). • Check to see if the Status LEDs turn green as a result of the above efforts. For details, refer to “Check the indicators and settings” on page 9.
Interference with a WiFi network, telephone, TV, or other electronic device	<ul style="list-style-type: none"> • For interference with a WiFi network, use the Channel button on the connection panel of the transmitter to alleviate the problem. For details, refer to “The transmitter Channel button” on page 9. • For interference with a telephone, TV, or other electronic device, move the transmitter or receiver farther from the device.

REFERENCE

Interference from a microwave oven	<ul style="list-style-type: none"> • Reposition the transmitter so it is in a more open area. • Move the receiver farther from the microwave.
Sound heard in the expansion room is not coming from your media center or audio source	<p>Change the Setup code switches on both the transmitter and the receiver, making sure they are identical. This may prevent signals from another AL8 transmitter in the vicinity from reaching your receiver.</p> <p>Try different switch settings. Your other options are: 1 & 2 up; 1 up & 2 down; or 1 down & 2 up.</p>
Unexpected sound from the media center	<p>Change the house code settings in both your LIFESTYLE® system and any remote controls you are using with it.</p> <p>This may prevent another nearby LIFESTYLE® system from affecting the operation of your system.</p> <p>For further information on house codes and how to change them, refer to the owner's guides that came with your LIFESTYLE® system and Bose® link remote controls.</p>

Contacting Customer Service

For additional help in solving problems, contact Bose Customer Service. Refer to the address sheet included in the carton.

Limited warranty

This system is covered by a transferable limited warranty.

Details of the limited warranty are provided on the Product Registration Card that came with your system. Please fill out the information section on the card and mail it to Bose. Failure to do so, however, will not affect your limited warranty rights.

Technical Information

Power rating

9.5V ~ 1.0A

Power supply rating

Input: 220-240V ~ 50Hz 60mA

Output: 9.5V ~ 1.0A

Operating temperature range

0° to 40°C (32° to 104°F)

Frequency band

2.4000 GHz to 2.4835 GHz

Transmitter Audio Input Level

2 Vrms (fixed)

Receiver Audio Output Level

2 Vrms (fixed)

RF Transmit power

Less than 100mW EIRP

Dimensions

Transmitter: 3"H x 6"W x 6"D (7.6 x 15.2 x 15.2 cm)

Receiver: 3"H x 6"W x 6"D (7.6 x 15.2 x 15.2 cm)

Weight

Transmitter: 1 lb (0.5 kg)

Receiver: 1 lb (0.5 kg)



289659-001

BOSE[®]
Better sound through research[®]

©2006 Bose Corporation, The Mountain,
Framingham, MA 01701-9168 USA
289659 AM Rev.01 CCM-002307